

Company: **Bass Strait Oil Company**
 Well: **Melville-1** **8.5 in. hole**
 Field: **Gippsland Basin**
 Rig: **Ocean Bounty** State: **Victoria**

Rig: Ocean Bounty Field: Gippsland Basin Location: Gippsland, Victoria Well: Melville-1 Company: Bass Strait Oil Company	Schlumberger VISION Resistivity 1:200 Measured Depth Recorded Mode					
	Total depth:	3,345 m	Elevation	K.B. Top Drive G.L. -100 m D.F. 25 m		
Spud date:		17 Oct 01				
Runs:		1 To 7				
Permanent datum:		LAT	Elev.:	0.0 m		
Log measured from:		Drill Floor	25 m	above Perm. datum		
Depth reference:		Drillers Pipe Tally				
API serial no.	Longitude		Latitude			
	S 38°41'2.967		E 147°59'8.391			
Depth logged:	1,429 m To 2,689 m	Mag decl: 13.17 deg	Other services:			
Date logged:	23 Oct 01 To 13 Nov 01	Mag dip: -69.20 deg	MWD			
Bore hole record			Casing record			
Hole size	from	to	Size	Density	from	to
12.25 in.	1,438 m	2,706 m	9-5/8 in.	47 lb/ft	1,429 m	2,700 m
8.5 in.	2,706 m	3,345 m				
Mud record			Borehole deviation record			
Type	from	to	Min	Max	from	to
KCl/Polymer	1,428 m	2,706 m	0.95 deg	2.59 deg	1,428 m	2,706 m
KCl/Polymer	2,706 m	3,345 m	0.65 deg	2.96 deg	2706 m	3,345 m
Surface equipment		Software record		IDEAL services from Anadrill		
Unit	ISPW-EA	IDEAL Wis	6.1c_10r			
Depth system	Geograph	SPM	6.1c_10r			
		LWD	6.4			
		MWD	6.1			

Bit Run Summary

Run number					7	
Bit size	inch	8.5	8.5			
Bit start depth	meter	2,706 m	2,856 m	3,102 m	3,102 m	
Bit end depth	meter	2,856 m	3,102 m	3,097 m	3,097 m	
Top interval logged	meter	2,700 m	2,843 m	3,097 m	3,340 m	
Bottom interval logged	meter	2,843 m	3,097 m	12:30 hrs	07:47 hrs	
Begin log: time		23:38 hrs	06-Nov-01	08-Nov-01	11-Nov-01	
Begin log: date		11:30 hrs	07-15 hrs	18:00 hrs		
End log: time		08-Nov-01	11-Nov-01	13-Nov-01		
End log: date						
Mud data						
Depth	meter	2,856 m	3,102 m	3,345 m		
Type		KCl/Polymer	KCl/Polymer	KCl/Polymer		

Type		KCl/Polymer	KCl/Polymer	KCl/Polymer						
Mud weight	sg	1.16	1.12	1.12						
Solids	% vol	5.6	5.2	5.2						
Chlorides	mg/l	31,500	32,500	31,500						
Rm	ohm.m@degC	0.111@23	0.125@23	0.126@22						
Rmf	ohm.m@degC	0.096@23	0.108@23	0.109@22						
Rmc	ohm.m@degC	0.074@23	0.165@23	0.103@22						
Potassium	ppb	23.5	21.8	21.8						
Environmental data										
GR										
Mud weight	sg	1.16	1.12	1.12						
Bit size	inch	8.5	8.5	8.5						
Resistivity										
Neutron porosity										
Hole Size	inch	8.5	8.5	8.5						
Mud weight	sg	1.16	1.12	1.12						
Temperature	degC	83	87	97						
Mud salinity	n/a	n/a	n/a	n/a						
Formation salinity	n/a	n/a	n/a	n/a						
Recording rate 1	SEC	10 sec	ARC_RES							
Recording rate 2	SEC	10 sec	ARC_GR							
Filtering GR		n/a	n/a							
Filtering density		n/a	n/a							
Filtering Neutron		n/a	n/a							
Company representative		D. Bell	M. Jackson	S. Douglas	G. Weste	C. Menhennitt				
Anadrill personnel		A. Abad	M. Saicic							

DISCLAIMER

THE USE OF AND RELIANCE UPON THIS RECORDED-DATA BY THE HEREIN NAMED COMPANY (AND ANY OF ITS AFFILIATES, PARTNERS, REPRESENTATIVES, AGENTS, CONSULTANTS AND EMPLOYEES) IS SUBJECT TO THE TERMS AND CONDITIONS AGREED UPON BETWEEN SCHLUMBERGER AND THE COMPANY, INCLUDING: (a) RESTRICTIONS ON USE OF THE RECORDED-DATA; (b) DISCLAIMERS AND WAIVERS OF WARRANTIES AND REPRESENTATIONS REGARDING COMPANY'S USE OF AND RELIANCE UPON THE RECORDED-DATA; AND (c) CUSTOMER'S FULL AND SOLE RESPONSIBILITY FOR ANY INFERENCE DRAWN OR DECISION MADE IN CONNECTION WITH THE USE OF THIS RECORDED-DATA.

<p>OTHER SERVICES FOR RUN5 MWD Powerpak Motor</p>	<p>OTHER SERVICES FOR RUN6 MWD</p>	<p>OTHER SERVICES FOR RUN7 MWD</p>
<p>REMARKS: RUN NUMBER 5 Rotary Drilled from: 2706 m to 2856 m Depth Logged from: 2700 m to 2843 m</p> <p>ARC GR is corrected for bit size and mud weight. ARC Resisitivity is borehole compensted but not environmentally corrected.</p> <p>Reaming operation performed on the way to bottom to log rat hole from 2700 m to 2710m.</p> <p>All recorded memory data was dumped from the tool and processed.</p> <p>POOH due to slow ROP.</p>	<p>REMARKS: RUN NUMBER 6 Rotary Drilled from: 2856 m to 3102 m Depth Logged from: 2843 m to 3097 m</p> <p>ARC GR is corrected for bit size and mud weight. ARC Resisitivity is borehole compensted but not environmentally corrected.</p> <p>Reaming operation performed on the way to bottom to log depth interval when motor was laid down. Ream down started from 2835 m to 2856 m. Logging speed at 50 m/hr.</p> <p>All recorded memory data was dumped from the tool and processed.</p> <p>POOH for a bit trip.</p>	<p>REMARKS: RUN NUMBER 7 Rotary Drilled from: 3102 m to 3345 m Depth Logged from: 3097 m to 3340 m</p> <p>ARC GR is corrected for bit size and mud weight. ARC Resisitivity is borehole compensted but not environmentally corrected.</p> <p>All recorded memory data was dumped from the tool and processed.</p> <p>This run resulted to TD of the well.</p>

EQUIPMENT DESCRIPTION

RUN5

RUN6

RUN7

DOWNHOLE EQ

DOWNHOLE E

DOWNHOLE EQ

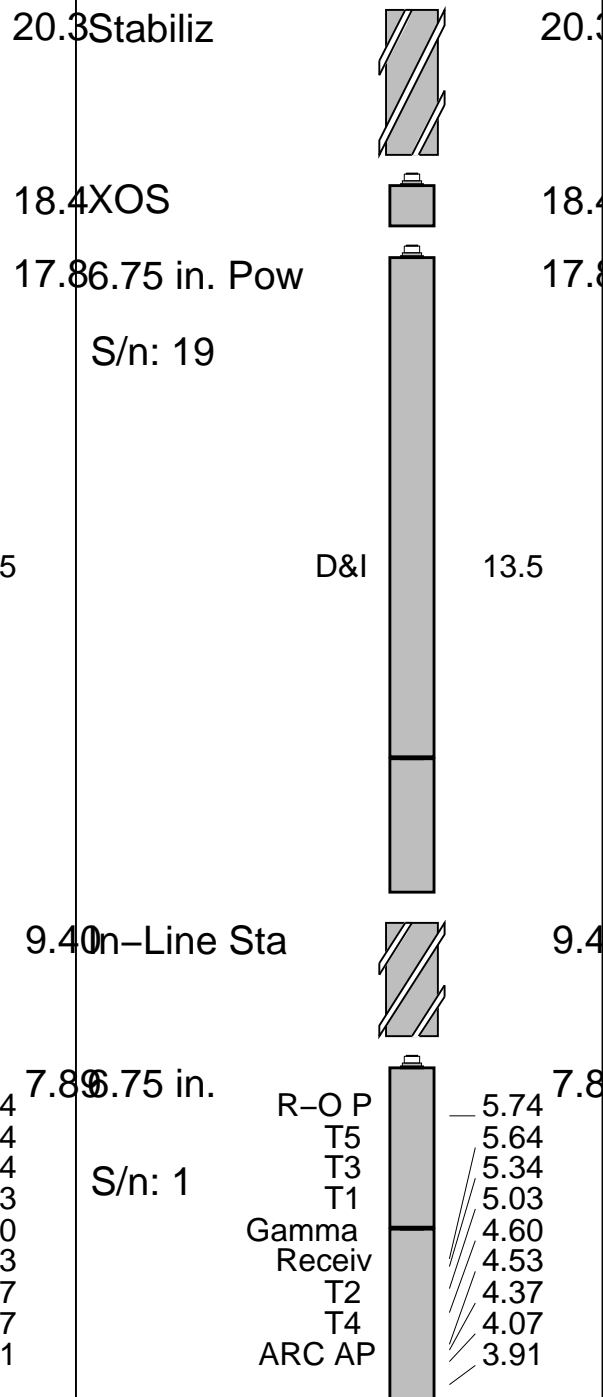
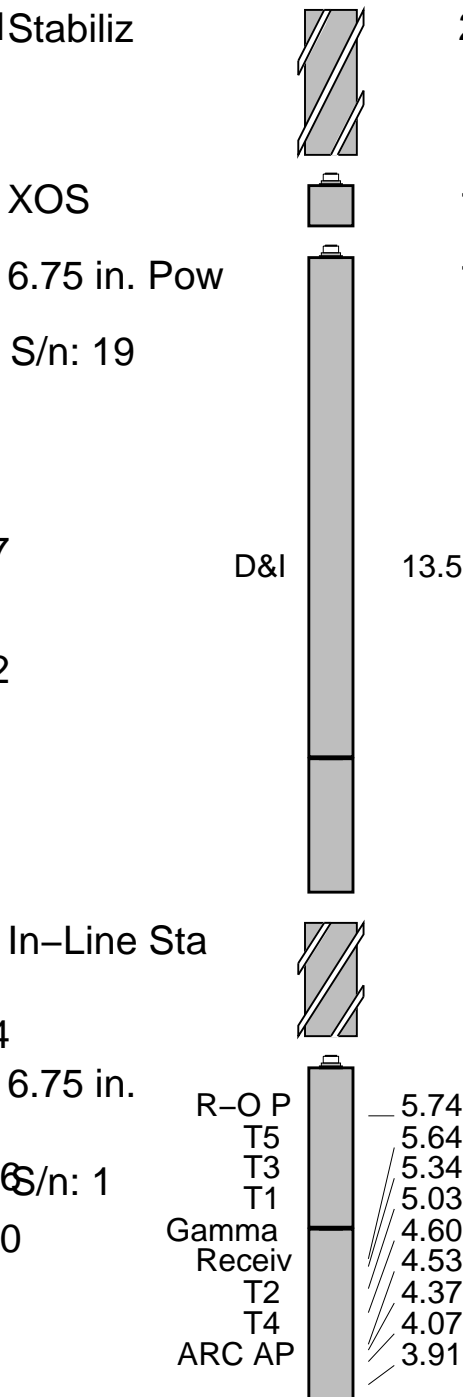
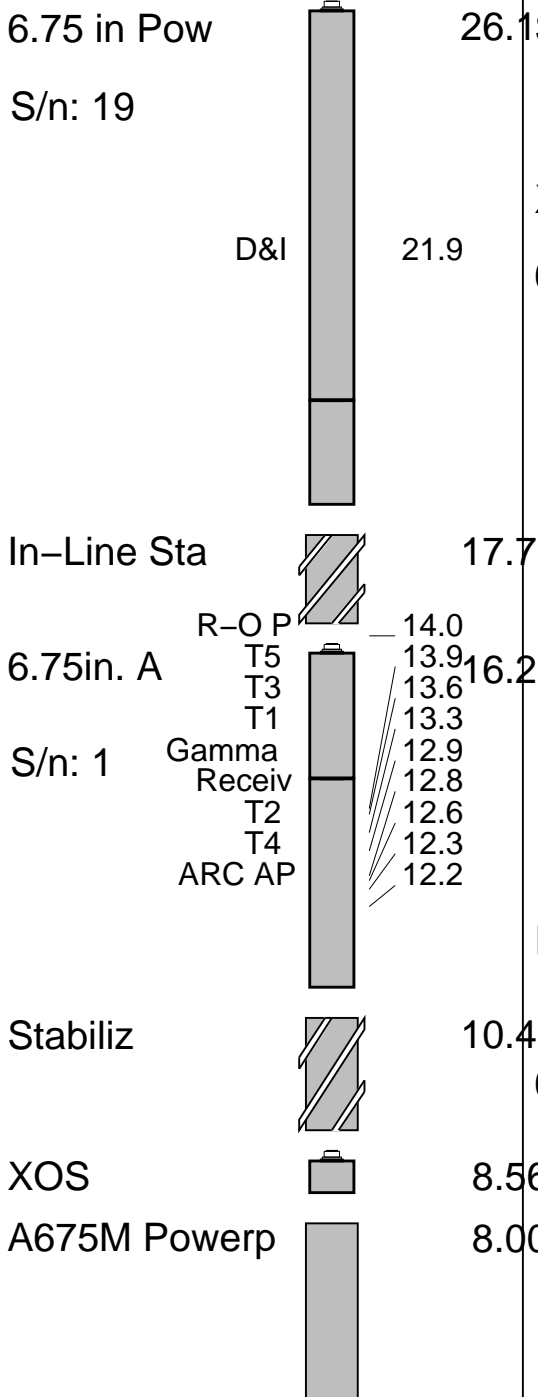

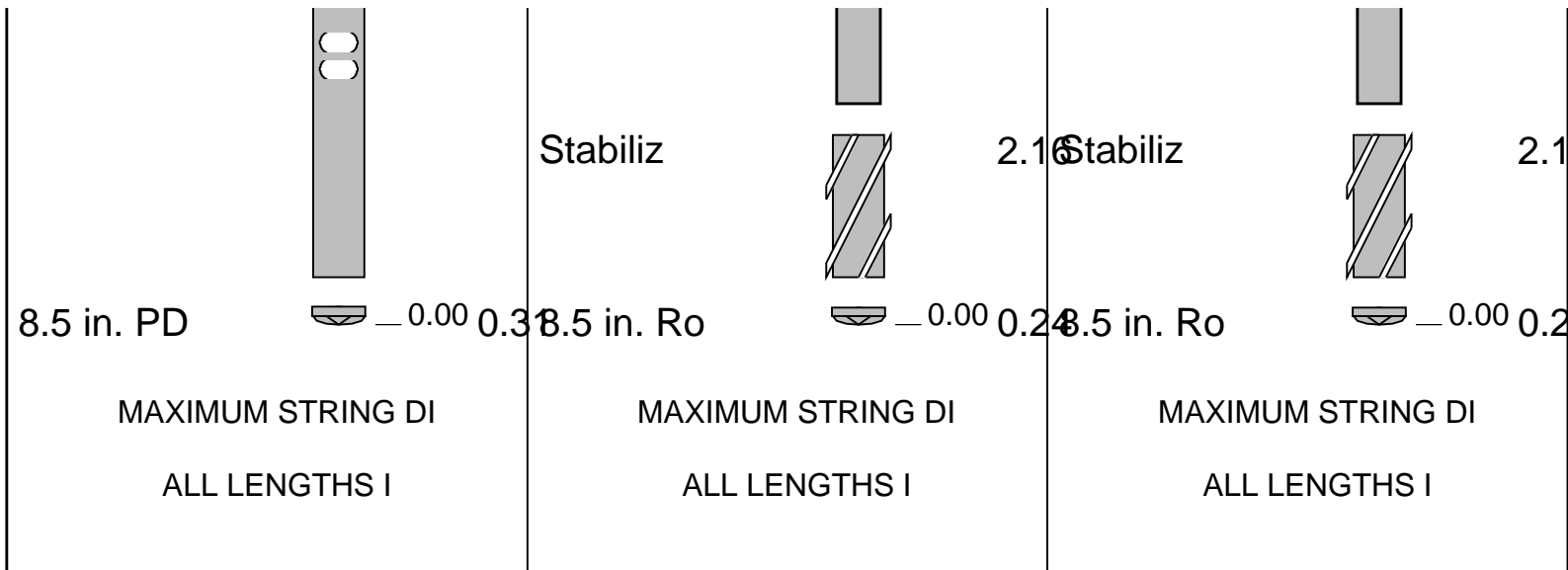

IDEAL Version: ID6_1C_10
IDF

ARC5_675 id6_1c_10 MWD_10 id6_1c_10

Format: ARC Dual 200 Vertical Scale: 1:200 Graphics File Created: 14-Nov-2001 13:05

Parameters

DLIS Name	Description	Value
AAPS	ARC5 Attenuation and Phase-Shift source	1_UPHOLE
APICG	ARC5 Gamma Ray API and Gain Combined Factor	1.147
ATRN	ARC5 Tool Run Number	MELV-1_8-8-5_R1
ATSN	ARC5 Tool Serial Number	117
BS_RM	Bit Size (RM)	8.500 in
DO	Depth Offset	0.0 m
KPER	ARC5:Potassium Concentration	6.000
MST_RM	Mud Sample temperature (RM)	22.780 degC
MW_RM	Mud Weight (RM)	1.120 g/cm3
RMS_RM	Resistivity of Mud Sample (RM)	0.126 ohm.m
VERS_ARC	ARC5 Down hole software version Number	6.400
WRK	ARC5: Way to Report Potassium Concentration	POTASSIUM_BY_WEIGHT_%

PIP SUMMARY

- └ ARC Gamma Ray Samples
- └ ARC Resistivity Samples

	ARC5 Phase Shift Res. 40 inch 2MHz (P40H_UNC) 0.2 (OHMM) 2000		ARC5 Phase Shift Res. 40 inch 400kHz (P40L_UNC) 0.2 (OHMM) 2000
	ARC5 Phase Shift Res. 34 inch 2MHz (P34H_UNC) 0.2 (OHMM) 2000		ARC5 Phase Shift Res. 34 inch 400kHz (P34L_UNC) 0.2 (OHMM) 2000
ARC Gamma Ray (GR_ARC_FILT) 0 (GAPI) 200	ARC5 Phase Shift Res. 28 inch 2MHz (P28H_UNC) 0.2 (OHMM) 2000	ARC5 Attenuation Res. 40 inch 2MHz (A40H_UNC) 0.2 (OHMM) 2000	ARC5 Phase Shift Res. 28 inch 400kHz (P28L_UNC) 0.2 (OHMM) 2000
Rate of Penetration, 5 ft Filtered (ROP5_RM) 200 (M/HR) 0	ARC5 Phase Shift Res. 22 inch 2MHz (P22H_UNC) 0.2 (OHMM) 2000	ARC5 Attenuation Res. 34 inch 2MHz (A34H_UNC) 0.2 (OHMM) 2000	ARC5 Phase Shift Res. 22 inch 400kHz (P22L_UNC) 0.2 (OHMM) 2000
ARC5 Resistivity Time After Bit (TAB_ARC_RES) 0 (HR) 10	ARC5 Phase Shift Res. 16 inch 2MHz (P16H_UNC) 0.2 (OHMM) 2000	ARC5 Attenuation Res. 28 inch 2MHz (A28H_UNC) 0.2 (OHMM) 2000	ARC5 Phase Shift Res. 16 inch 400kHz (P16L_UNC) 0.2 (OHMM) 2000

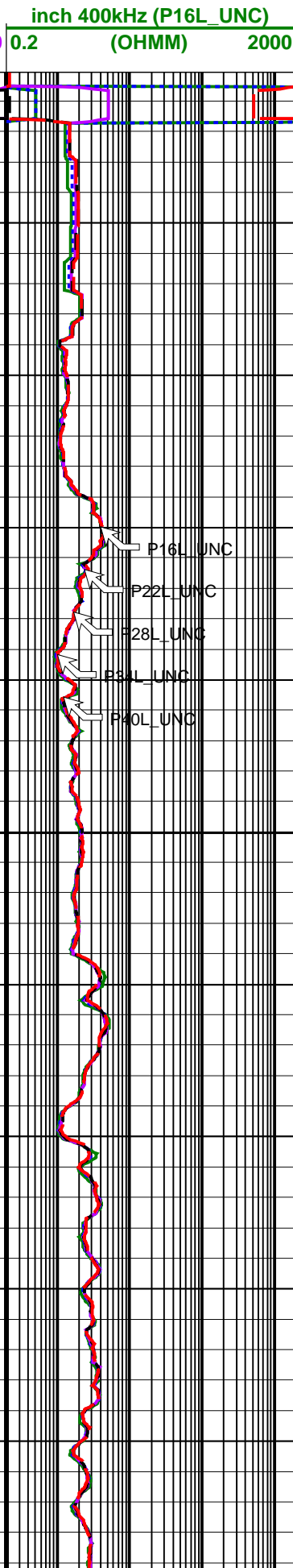
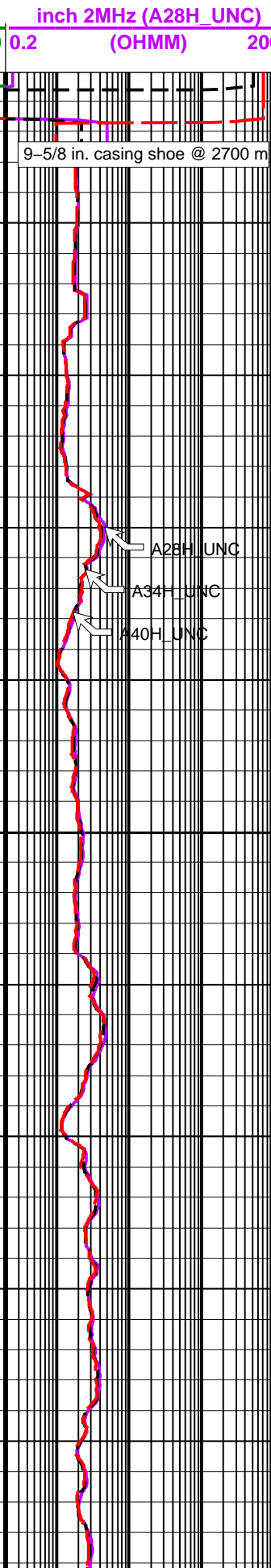
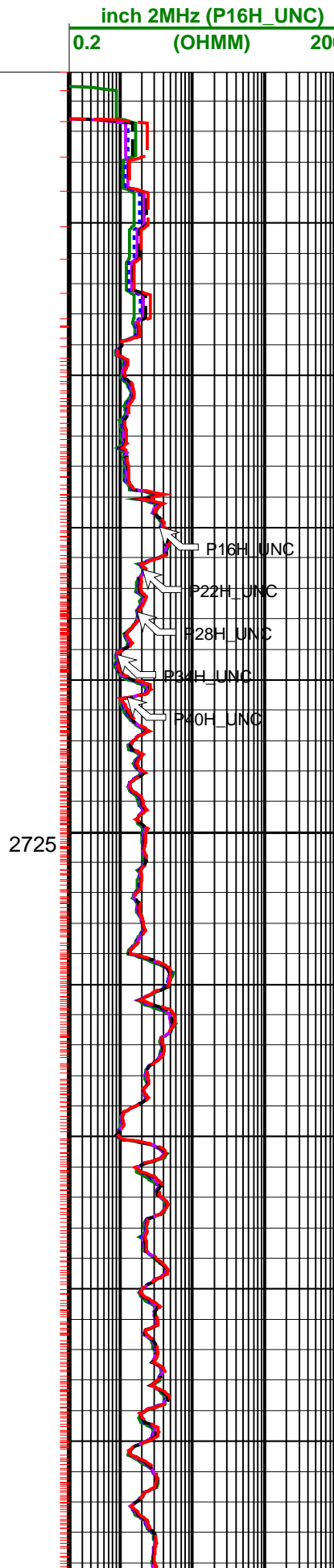
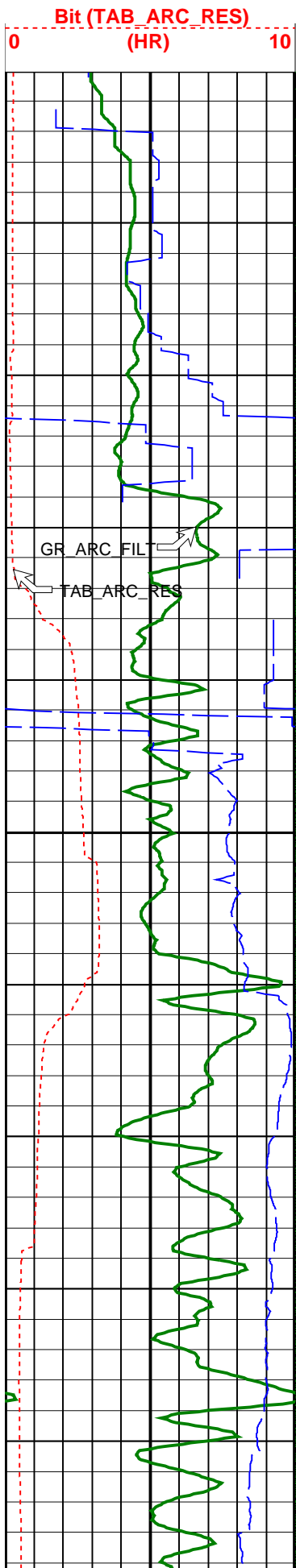

9-5/8 in. casing shoe @ 2700 m

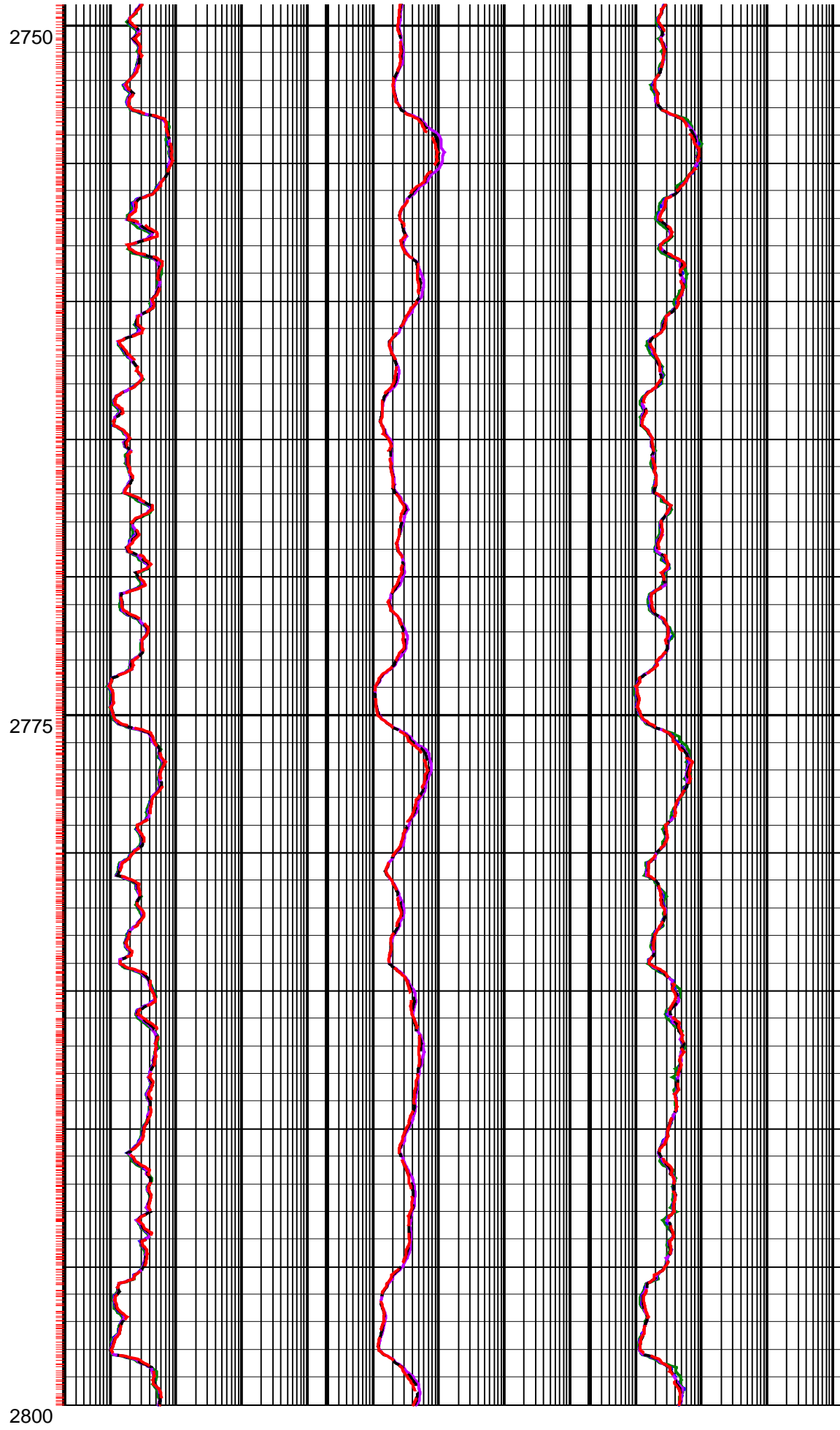
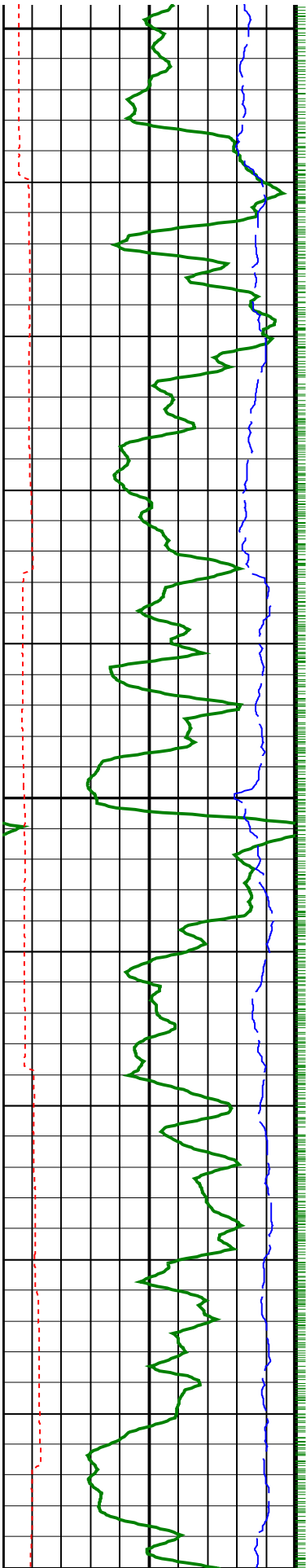

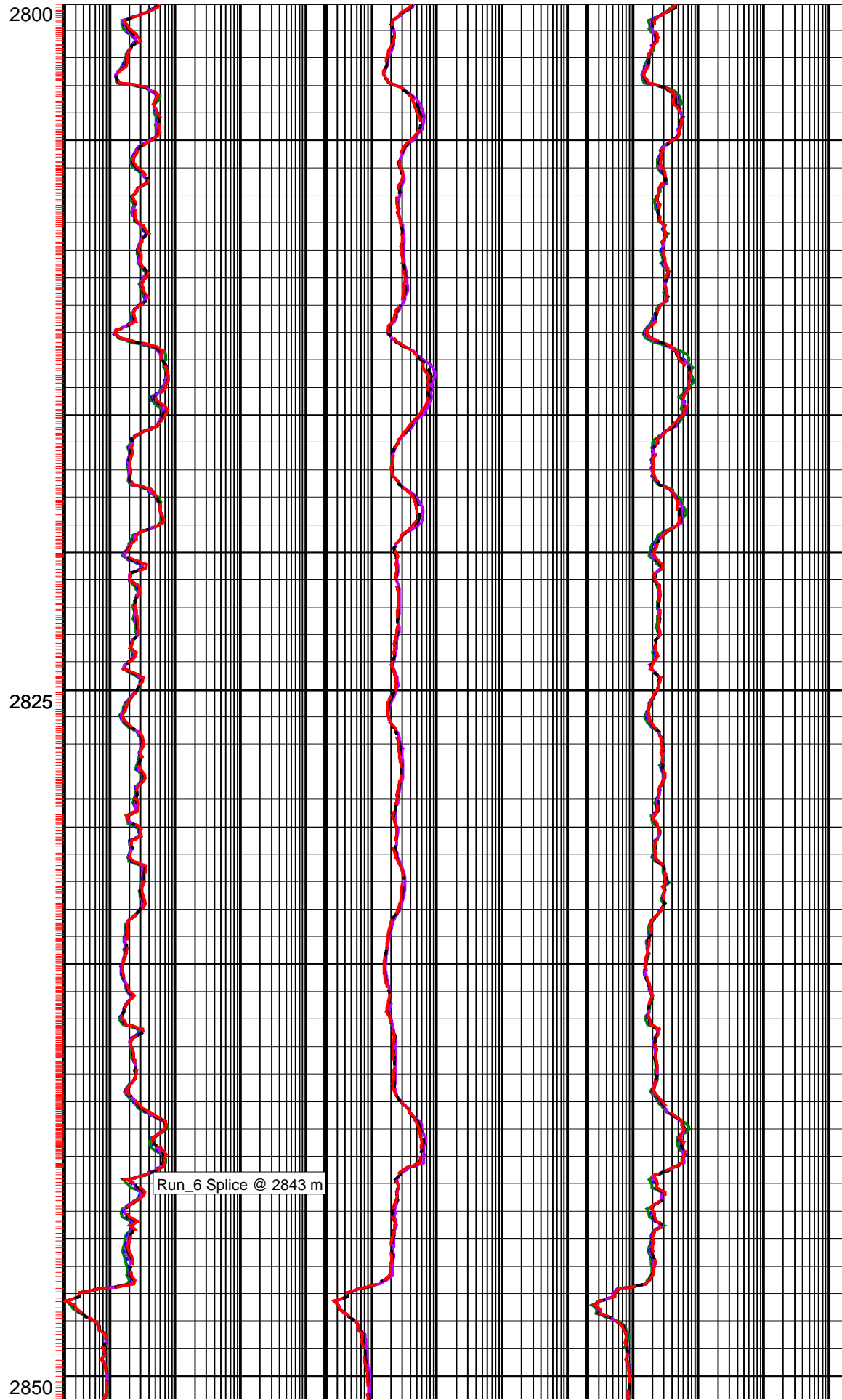
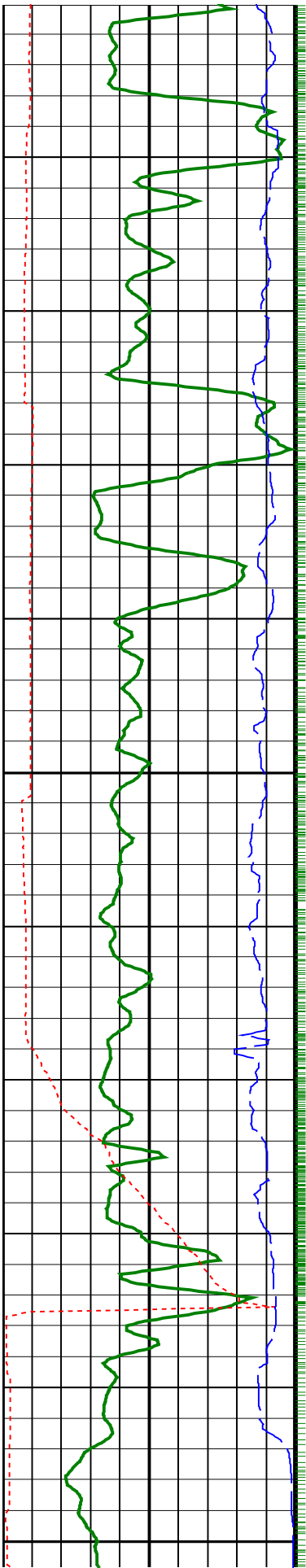

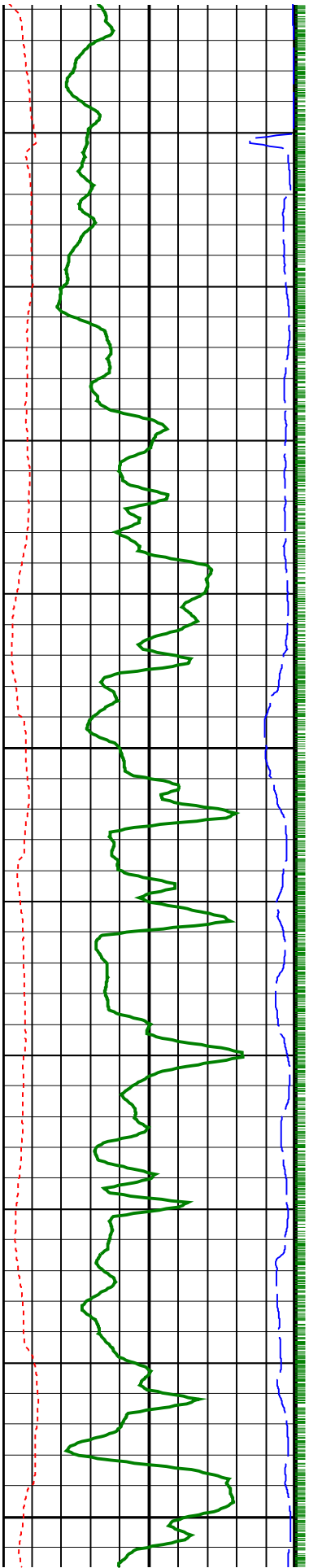

2850

2875

2900

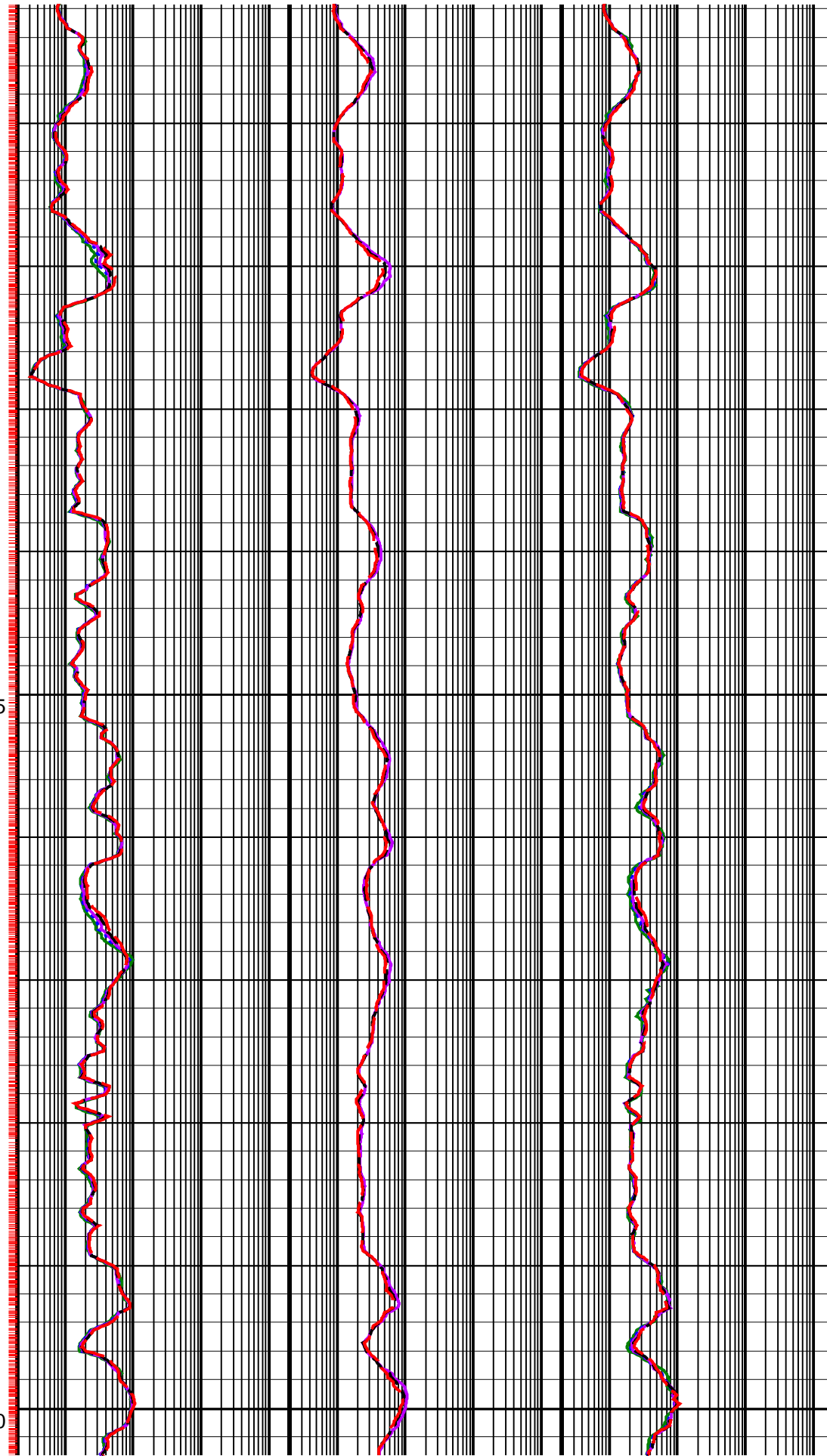

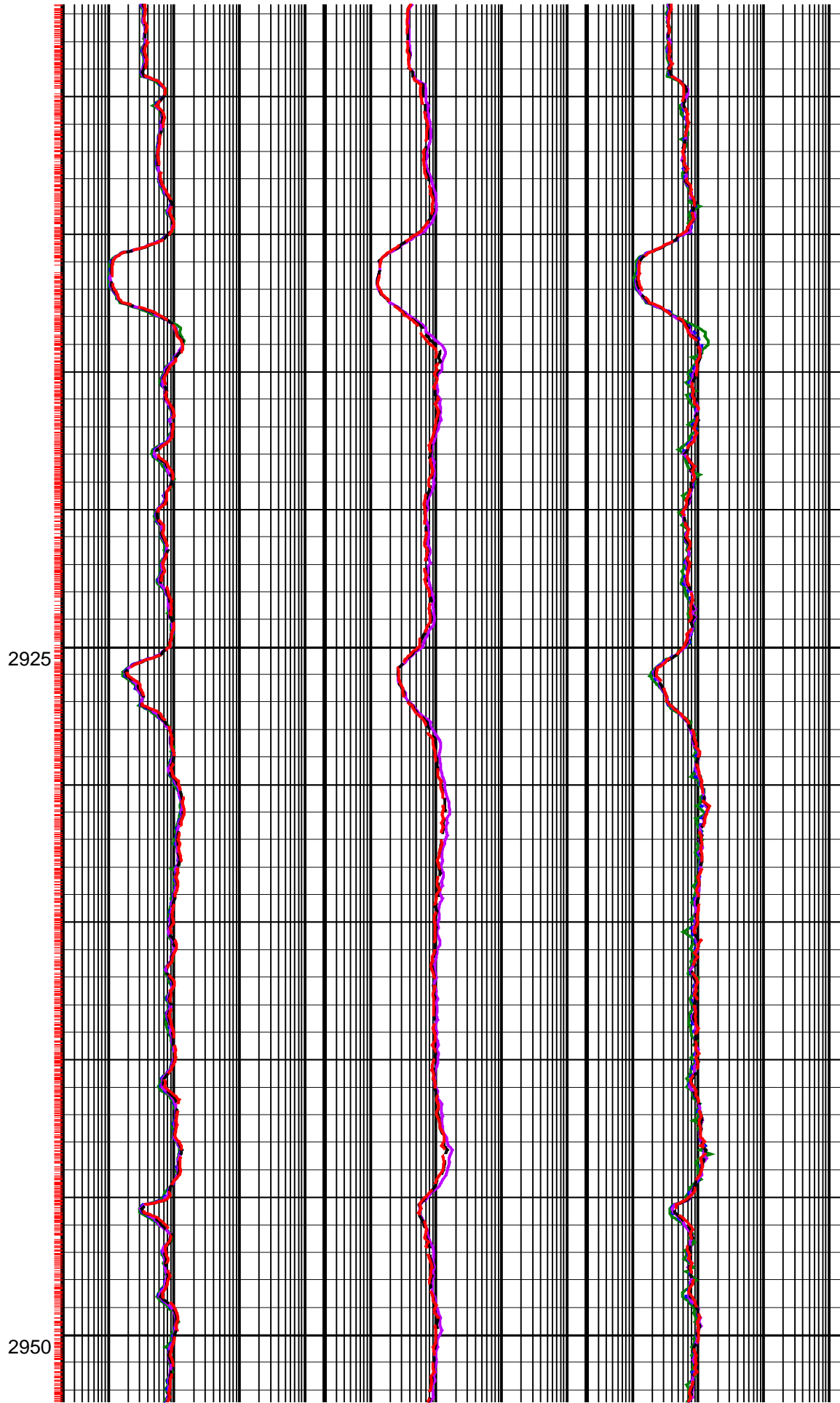
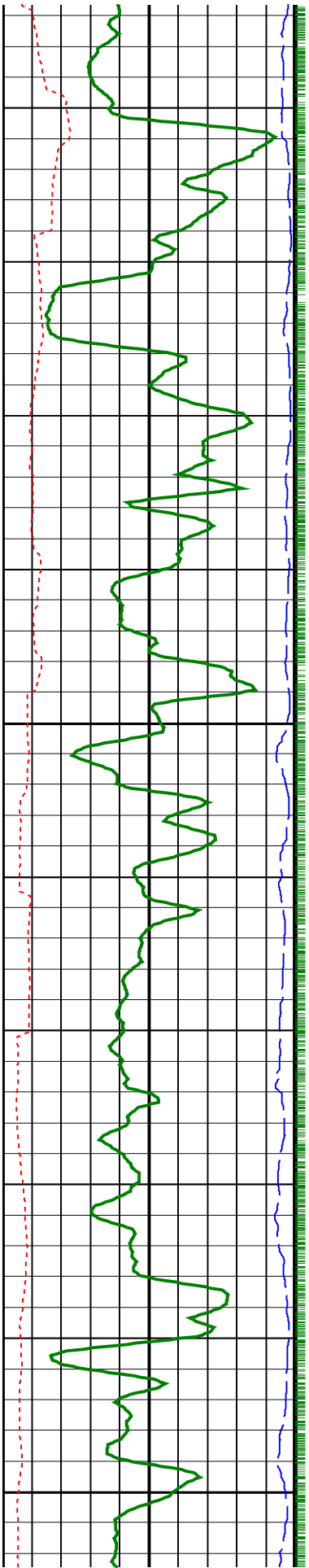

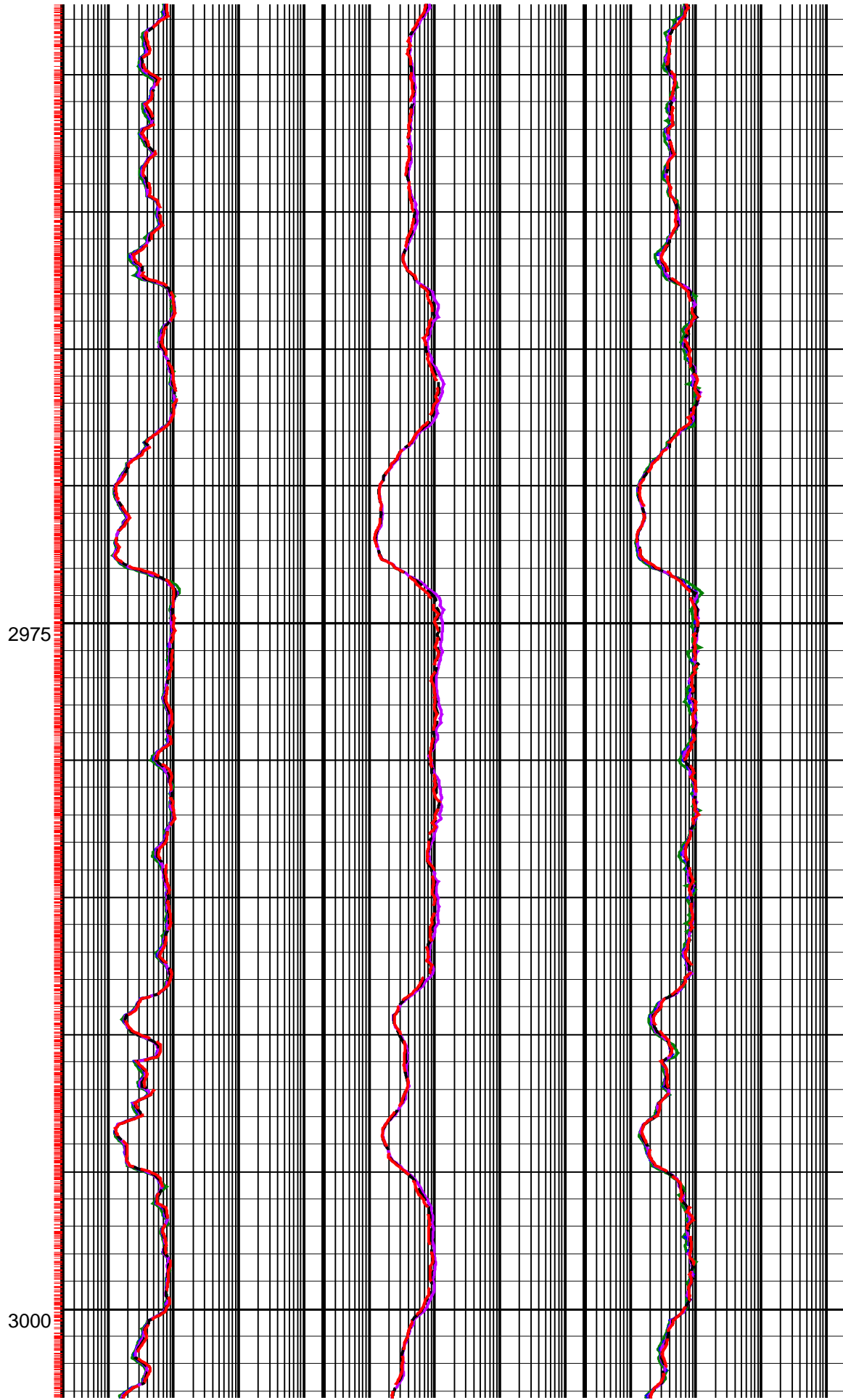
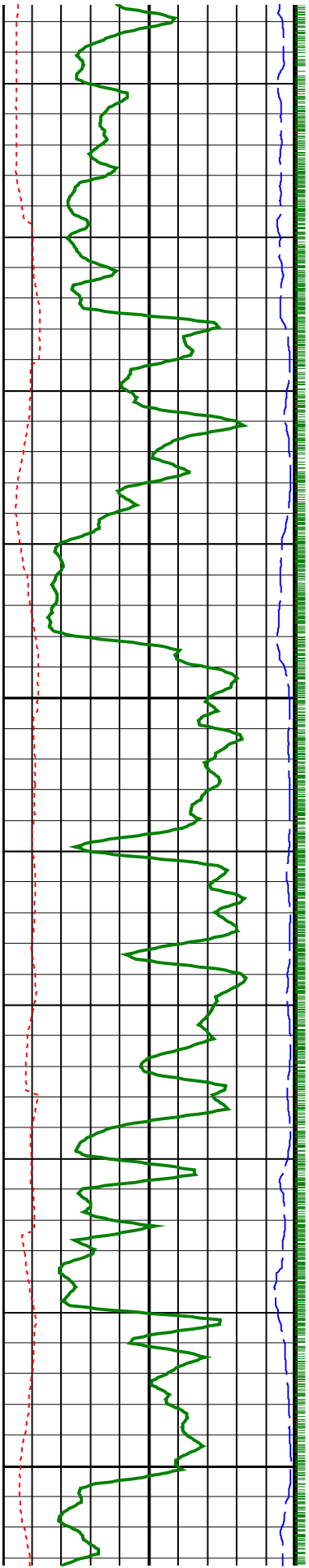

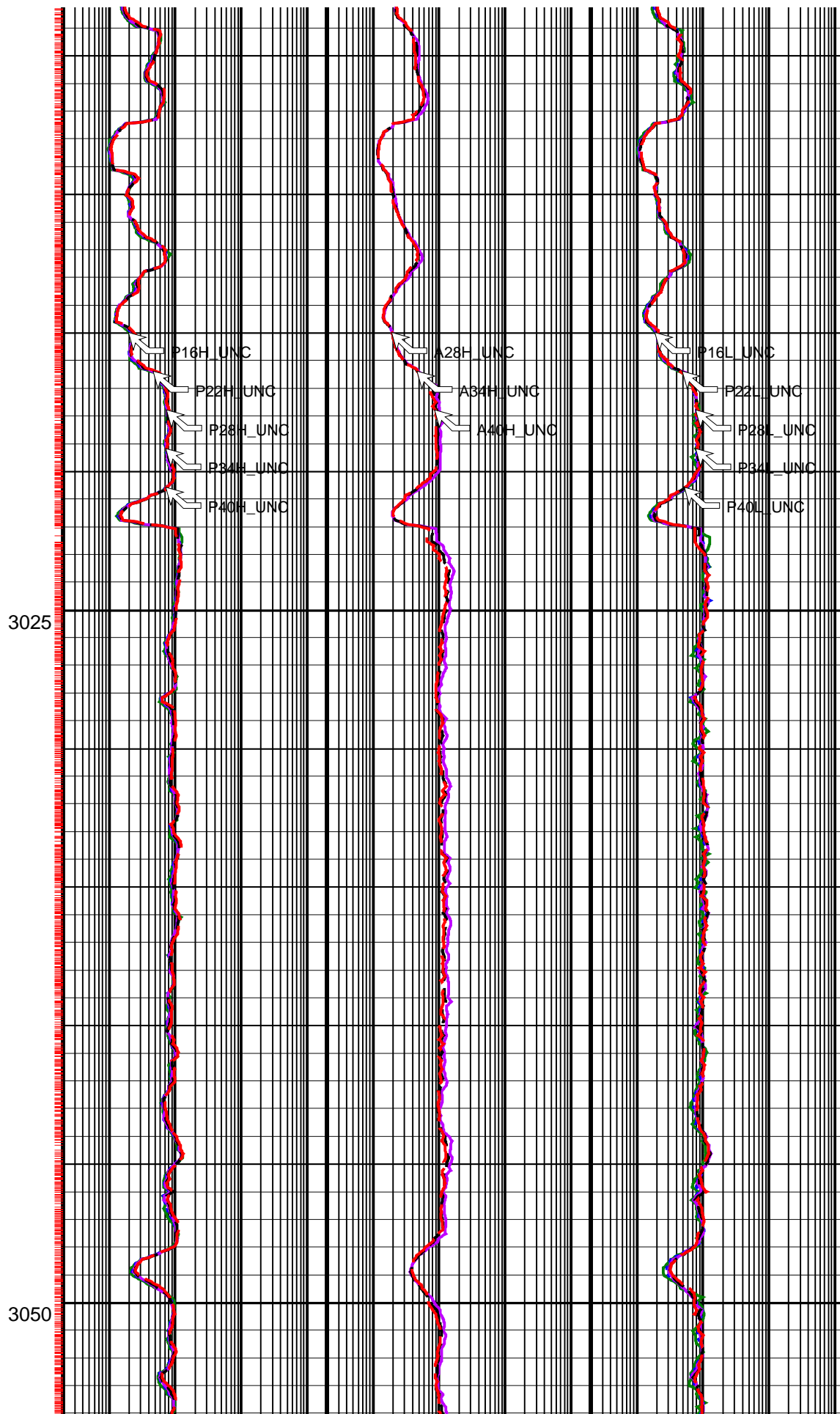
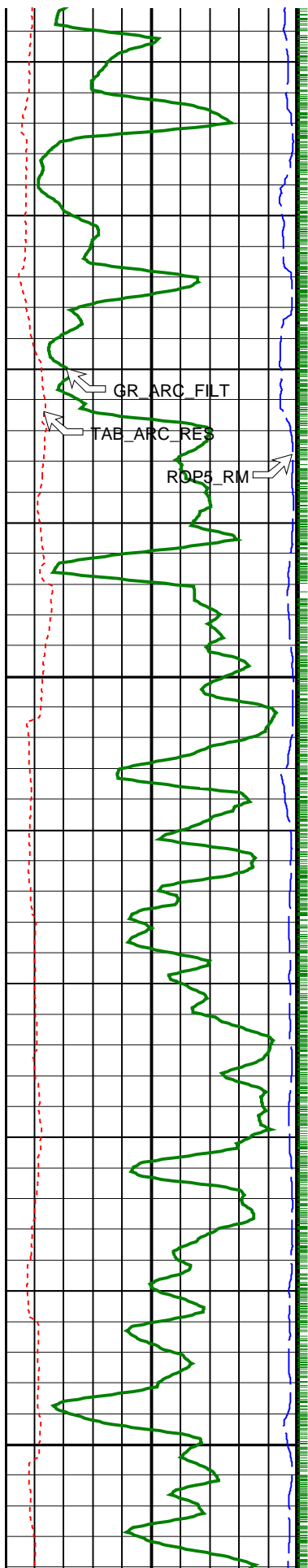

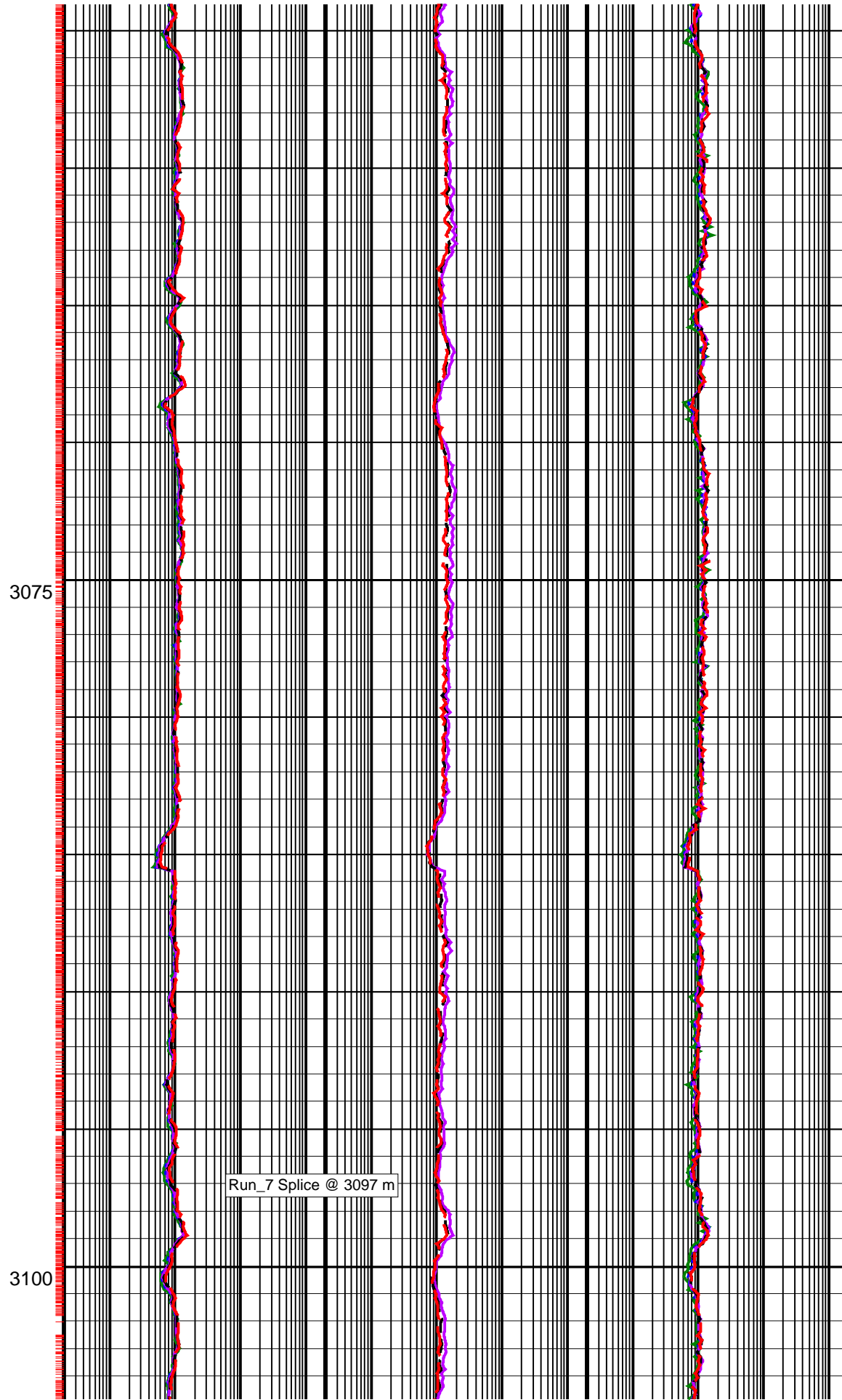
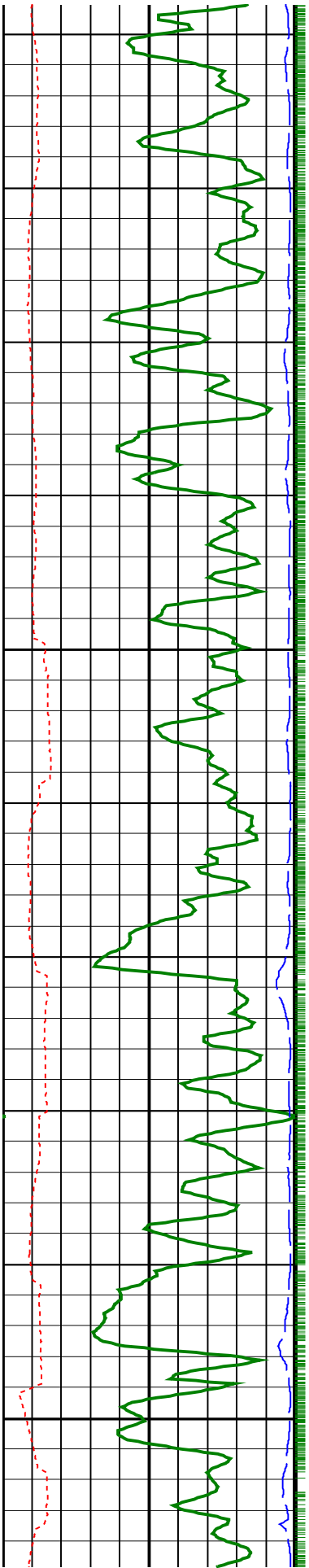

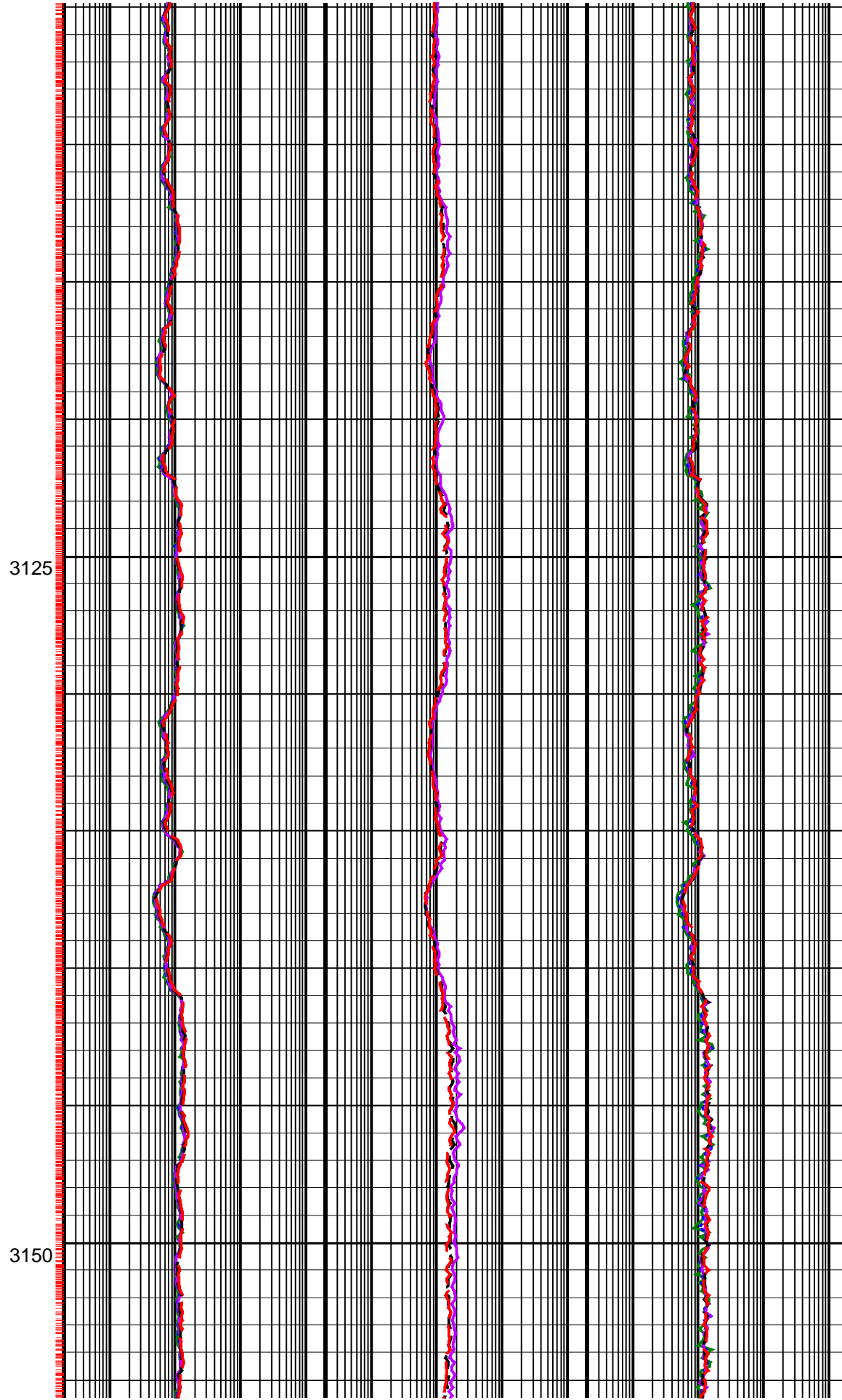
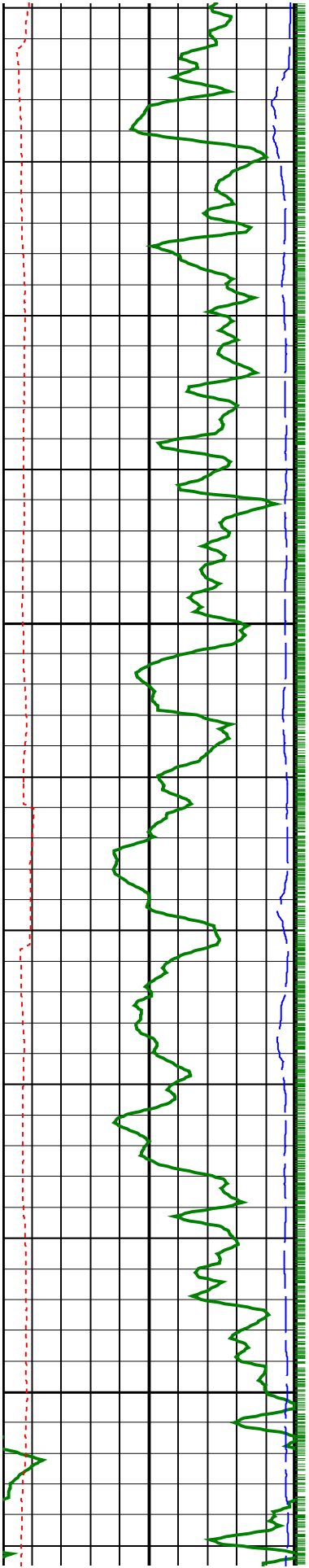

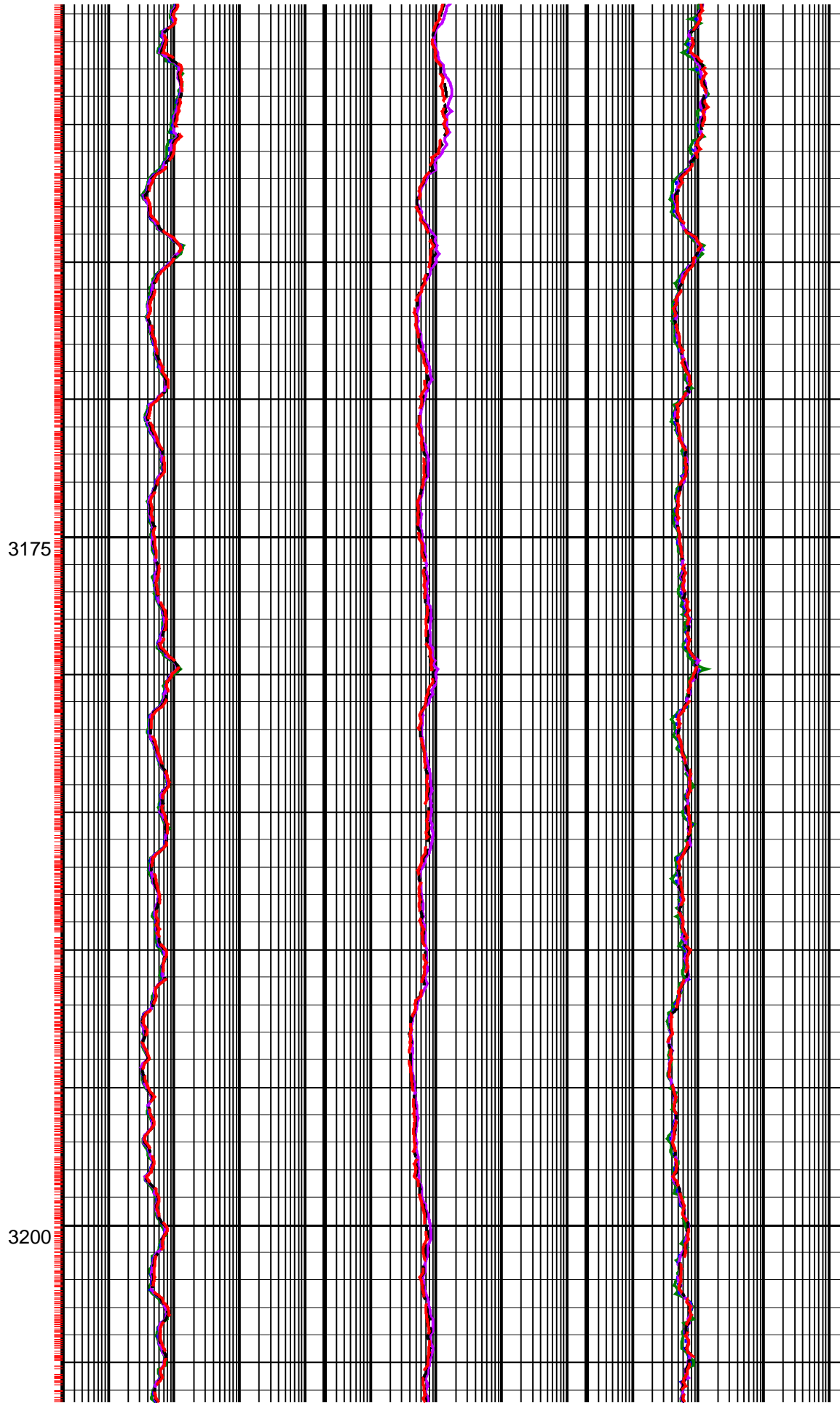
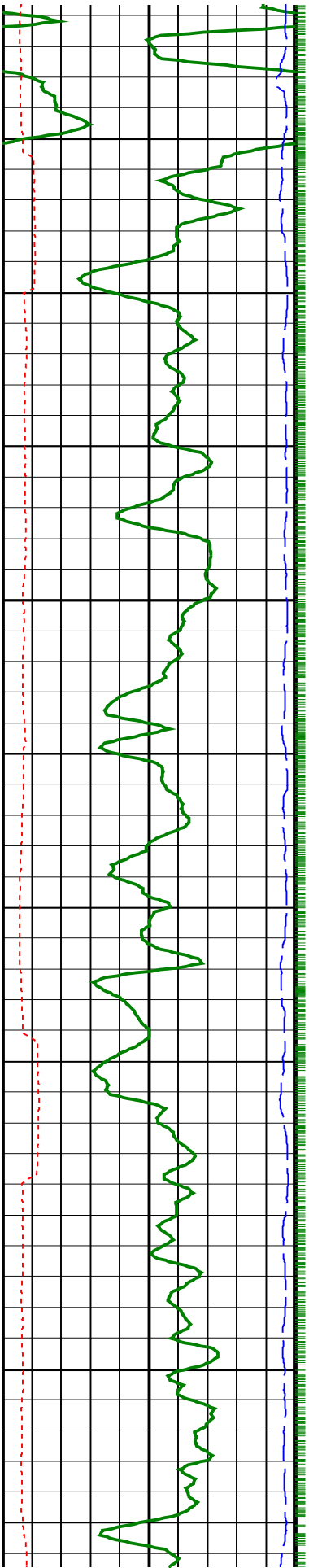

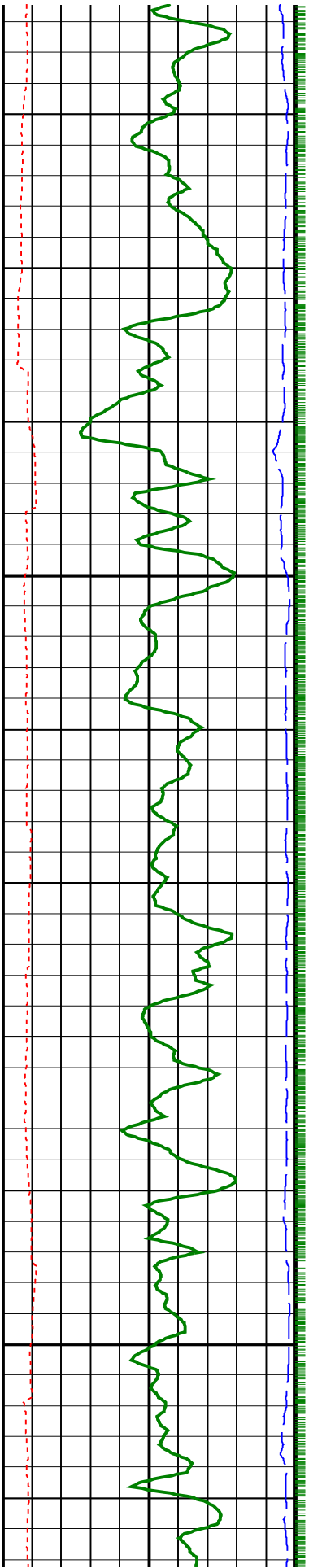

3225

3250

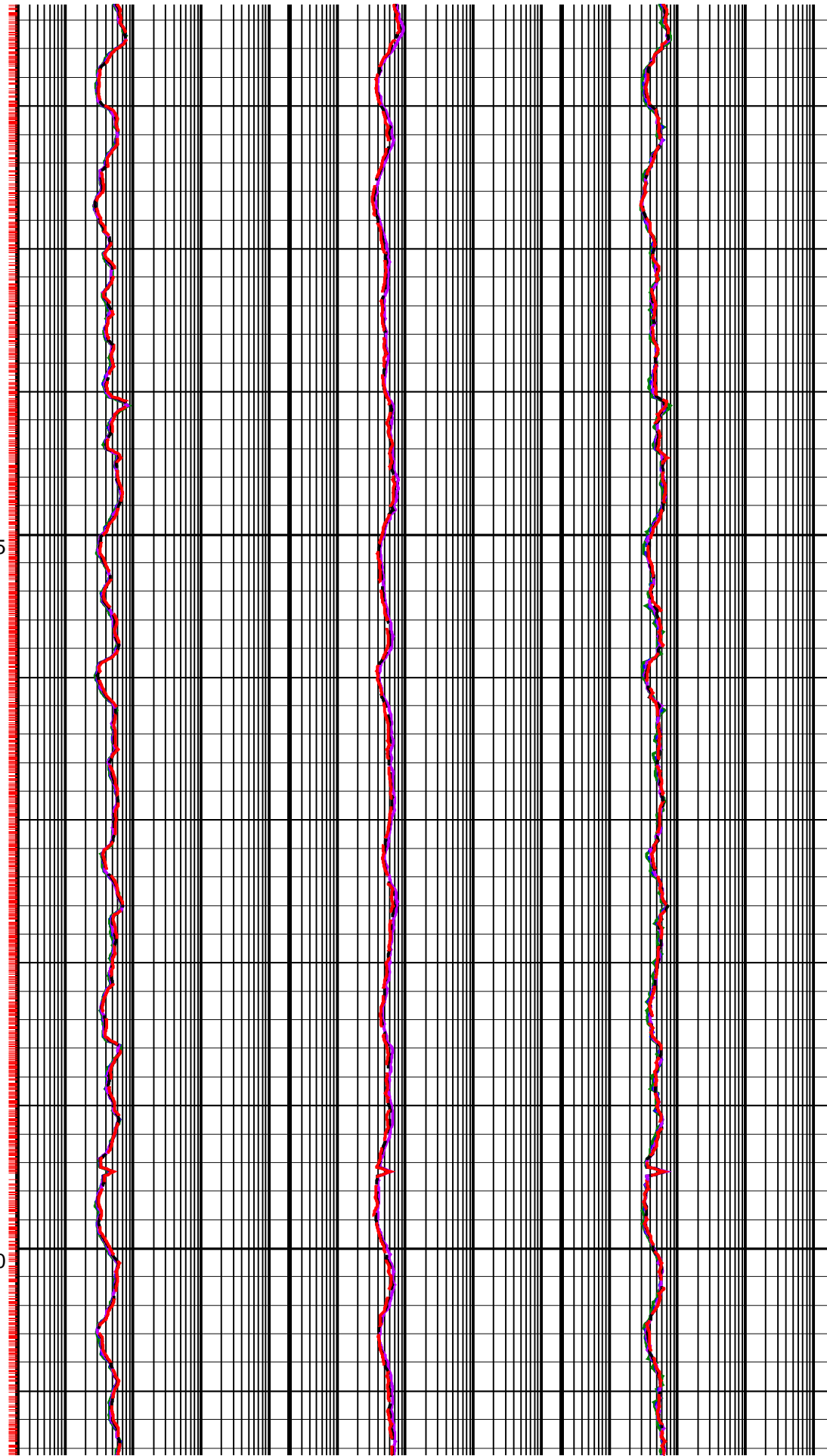

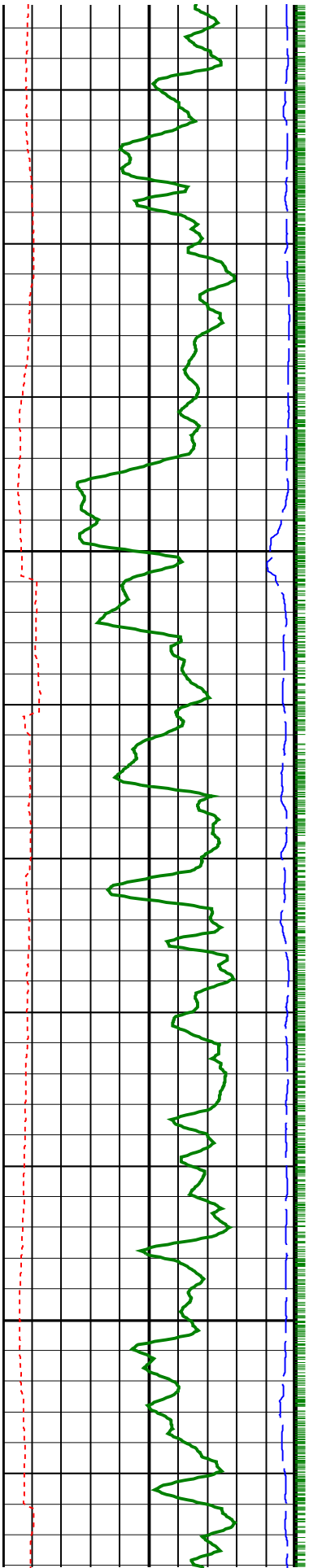

3275

3300

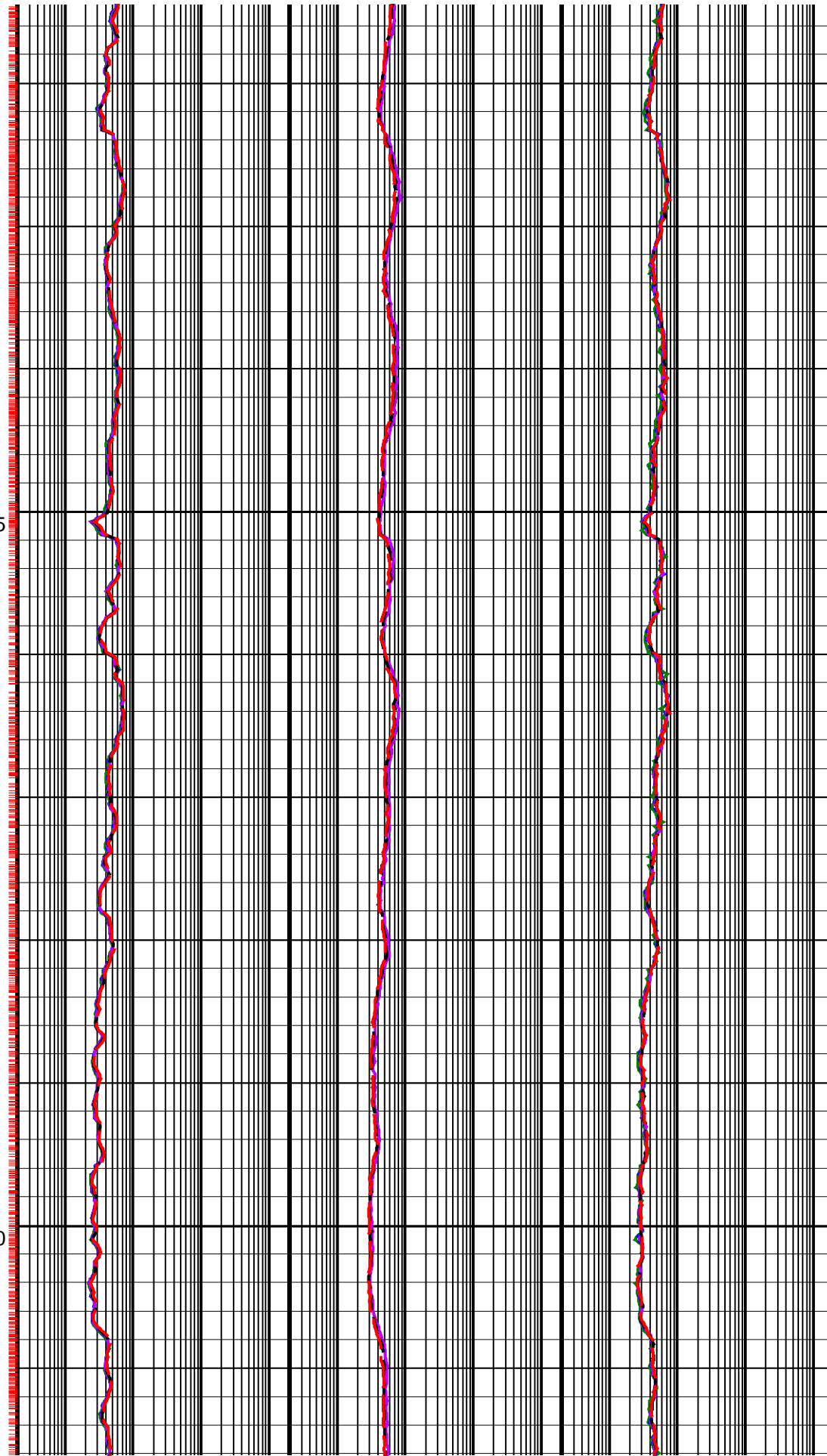

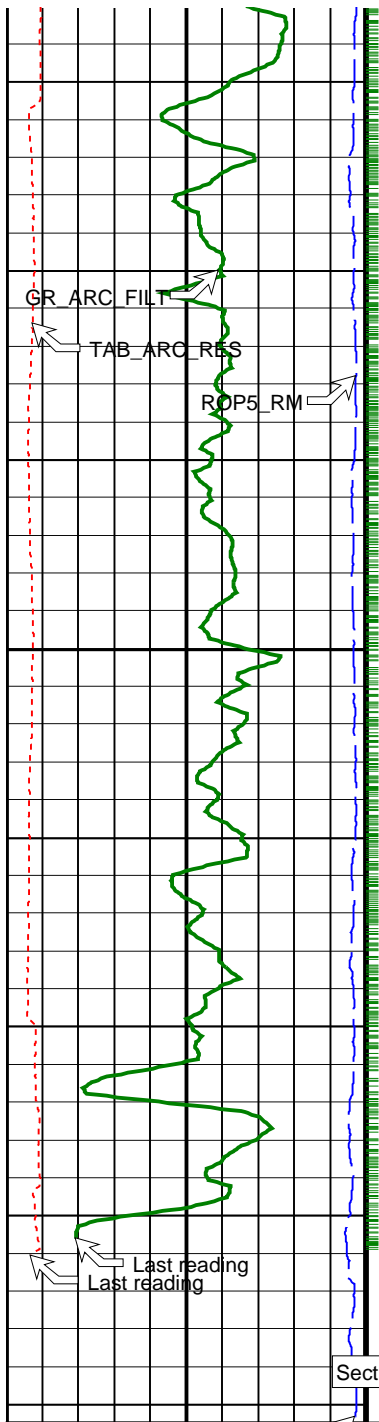

Section TD @ 3345 m

3325

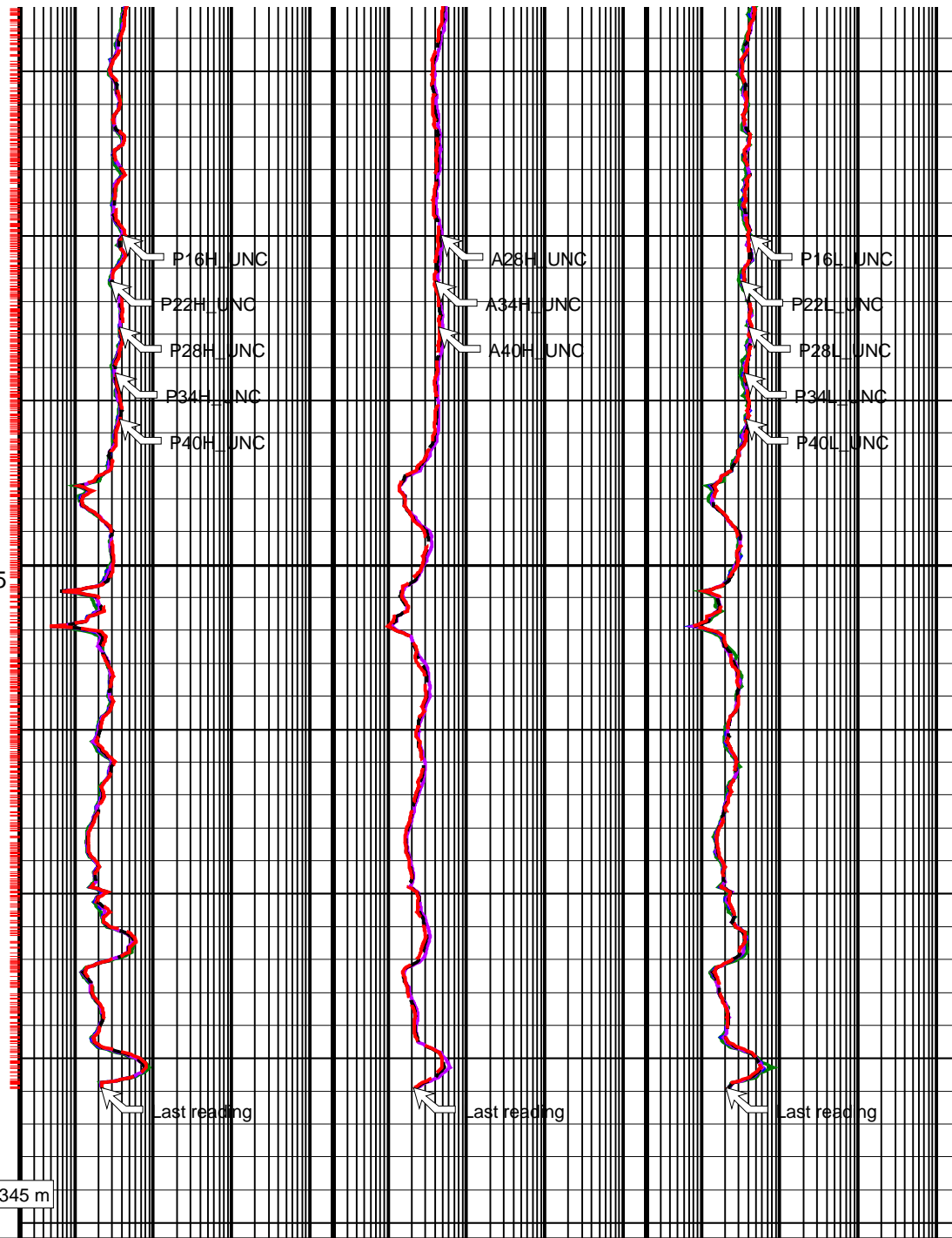

ARC5 Resistivity Reading Bit (TAB_ARC_RES) 0 (HR) 10		
Rate of Penetration, 5 ft Filtered (ROP5_RM) 200 (M/HR) 0		
ARC Gamma Ray (GR_ARC_FILT) 0 (GAPI) 200		

ARC5 Phase Shift Res. 16 inch 2MHz (P16H_UNC) 0.2 (OHMM) 2000
ARC5 Phase Shift Res. 22 inch 2MHz (P22H_UNC) 0.2 (OHMM) 2000
ARC5 Phase Shift Res. 28 inch 2MHz (P28H_UNC) 0.2 (OHMM) 2000
ARC5 Phase Shift Res. 34 inch 2MHz (P34H_UNC) 0.2 (OHMM) 2000
ARC5 Phase Shift Res. 40 inch 2MHz (P40H_UNC)

ARC5 Attenuation Res. 28 inch 2MHz (A28H_UNC) 0.2 (OHMM) 2000
ARC5 Attenuation Res. 34 inch 2MHz (A34H_UNC) 0.2 (OHMM) 2000
ARC5 Attenuation Res. 40 inch 2MHz (A40H_UNC) 0.2 (OHMM) 2000

ARC5 Phase Shift Res. 16 inch 400kHz (P16L_UNC) 0.2 (OHMM) 2000
ARC5 Phase Shift Res. 22 inch 400kHz (P22L_UNC) 0.2 (OHMM) 2000
ARC5 Phase Shift Res. 28 inch 400kHz (P28L_UNC) 0.2 (OHMM) 2000
ARC5 Phase Shift Res. 34 inch 400kHz (P34L_UNC) 0.2 (OHMM) 2000
ARC5 Phase Shift Res. 40 inch 400kHz (P40L_UNC)

**ARC5 Phase Shift Res. 40
inch 2MHz (P40H_UNC)**
0.2 (OHMM) 2000

**ARC5 Phase Shift Res. 40
inch 400kHz (P40L_UNC)**
0.2 (OHMM) 2000

PIP SUMMARY

- └ ARC Gamma Ray Samples
- └ ARC Resistivity Samples

**IDEAL Version: ID6_1C_10
IDF**

ARC5_675

id6_1c_10

MWD_10

id6_1c_10

6.75-in. Array Resistivity Compensated / Equipment Identification

Primary Equipment:
Tool Name and Serial Number

ARC6 - S/n: 117

Calibration date: 07-Sep-01

6.75-in. Array Resistivity Compensated Calibration

Resistivity: Air

Phase	Phase-Shift T1 DEG	Value	Phase	Phase-Shift T2 DEG	Value	Phase	Phase-Shift T3 DEG	Value
Master		-2.512	Master		2.776	Master		-2.626
	-3.900 (Minimum) 0.1000 (Nominal) 4.100 (Maximum)			-3.900 (Minimum) 0.1000 (Nominal) 4.100 (Maximum)			-3.900 (Minimum) 0.1000 (Nominal) 4.100 (Maximum)	
Phase	Phase-Shift T4 DEG	Value	Phase	Phase-Shift T5 DEG	Value	Phase	Phase-Shift T1 at 400KHz DEG	Value
Master		2.722	Master		-2.583	Master		-1.894
	-3.900 (Minimum) 0.1000 (Nominal) 4.100 (Maximum)			-3.900 (Minimum) 0.1000 (Nominal) 4.100 (Maximum)			-3.900 (Minimum) 0.1000 (Nominal) 4.100 (Maximum)	
Phase	Phase-Shift T2 at 400KHz DEG	Value	Phase	Phase-Shift T3 at 400KHz DEG	Value	Phase	Phase-Shift T4 at 400KHz DEG	Value
Master		2.074	Master		-1.944	Master		2.089
	-3.900 (Minimum) 0.1000 (Nominal) 4.100 (Maximum)			-3.900 (Minimum) 0.1000 (Nominal) 4.100 (Maximum)			-3.900 (Minimum) 0.1000 (Nominal) 4.100 (Maximum)	
Phase	Phase-Shift T5 at 400KHz DEG	Value						
Master		-1.943						
	-3.900 (Minimum) 0.1000 (Nominal) 4.100 (Maximum)							

Calibration date: 07-Sep-01

6.75-in. Array Resistivity Compensated Calibration

Resistivity: Air

Phase	Attenuation T1 DB	Value	Phase	Attenuation T2 DB	Value	Phase	Attenuation T3 DB	Value
Master		7.940	Master		7.156	Master		4.528
	6.500 (Minimum) 8.500 (Nominal) 10.50 (Maximum)			4.500 (Minimum) 6.500 (Nominal) 8.500 (Maximum)			2.500 (Minimum) 4.500 (Nominal) 6.500 (Maximum)	
Phase	Attenuation T4 DB	Value	Phase	Attenuation T5 DB	Value	Phase	Attenuation T1 at 400KHz DB	Value
Master		4.992	Master		3.037	Master		7.965
	2.600 (Minimum) 4.600 (Nominal) 6.600 (Maximum)			1.600 (Minimum) 3.600 (Nominal) 5.600 (Maximum)			6.500 (Minimum) 8.500 (Nominal) 10.50 (Maximum)	
Phase	Attenuation T2 at 400KHz DB	Value	Phase	Attenuation T3 at 400KHz DB	Value	Phase	Attenuation T4 at 400KHz DB	Value
Master		7.076	Master		4.557	Master		4.960
	4.500 (Minimum) 6.500 (Nominal) 8.500 (Maximum)			2.500 (Minimum) 4.500 (Nominal) 6.500 (Maximum)			2.600 (Minimum) 4.600 (Nominal) 6.600 (Maximum)	
Phase	Attenuation T5 at 400KHz DB	Value						
Master		3.109						
	1.600 3.600 5.600							

1.600 (Minimum) 3.600 (Nominal) 5.600 (Maximum)

Calibration date: 07-Sep-01

6.75-in. Array Resistivity Compensated Calibration

Gamma Ray: Blanket

Phase	Gamma ray factor (equals Calibration Gain multiplied by API Gain Factor) CPS			Value
Master	[REDACTED]			5.506
	2.780 (Minimum)	4.800 (Nominal)	6.000 (Maximum)	

ANADRILL

SCHLUMBERGER

Survey report 13-Nov-2001 13:04:23 Page 1 of 3

Client.....: Bass Strait Oil Company
 Field.....: Permit VIC/P42

Well.....: Melville-1
 API number.....:
 Engineer.....: A. Abad / M. Saicic

Spud date.....: 17-Oct-01
 Last survey date.....: 13-Nov-01
 Total accepted surveys...: 60
 MD of first survey.....: 1432.10 m
 MD of last survey.....: 3345.00 m

COUNTY.....: Ocean Bounty
 STATE.....: Victoria

----- Survey calculation methods-----
 Method for positions.....: Minimum curvature
 Method for DLS.....: Mason & Taylor

----- Geomagnetic data -----
 Magnetic model.....: BGGM version 2000
 Magnetic date.....: 24-Oct-2001
 Magnetic field strength...: 1206.71 HCNT
 Magnetic dec (+E/W-).....: 13.17 degrees
 Magnetic dip.....: -69.20 degrees

----- Depth reference -----
 Permanent datum.....: L.A.T.
 Driller reference.....: Driller's Pipe Tally
 GL above permanent.....: -100.00 m
 KB above permanent.....: 75.00 m
 DF above permanent.....: 25.00 m

----- MWD survey Reference Criteria -----
 Reference G.....: 1000.07 mGal
 Reference H.....: 1206.71 HCNT
 Reference Dip.....: -69.20 degrees
 Tolerance of G..... (+/-) 2.50 mGal
 Tolerance of H..... (+/-) 6.00 HCNT
 Tolerance of Dip..... (+/-) 0.45 degrees

----- Vertical section origin-----
 Latitude (+N/S-).....: 0.00 m
 Departure (+E/W-).....: 0.00 m

----- Platform reference point-----
 Latitude (+N/S-).....: 5,717,796 m
 Departure (+E/W-).....: 585,729.8 m

----- Corrections -----
 Magnetic dec (+E/W-).....: 13.17 degrees
 Grid convergence (+E/W-)..: -1.17 degrees
 Total az corr (+E/W-).....: 14.34 degrees
 (Total az corr = magnetic dec - grid conv)
 Sag applied (Y/N).....: No degree: 0.00

Azimuth from rotary table to target: 0.00 degrees

[(c)2001 Anadrill IDEAL ID6_1C_10]
 ANADRILL SCHLUMBERGER Survey Report

13-Nov-2001 13:04:23 Page 2 of 3

Seq #	Measured depth (m)	Incl angle (deg)	Azimuth angle (deg)	Course length (m)	TVD depth (m)	Vertical section (m)	Displ +N/S- (m)	Displ +E/W- (m)	Total displ (m)	At Azim (deg)	DLS (deg/10m)	Srvy tool type	Tool qual type
1	1432.10	2.40	228.90	0.00	1432.00	-2.80	-2.80	-1.60	3.22	209.74	0.00	EMS	TIP
2	1443.09	2.50	236.20	10.99	1442.98	-3.08	-3.08	-1.97	3.66	212.60	0.30	MWD	6-axis
3	1494.71	2.59	236.48	51.62	1494.55	-4.35	-4.35	-3.88	5.83	221.70	0.02	MWD	6-axis
4	1557.58	2.56	237.49	62.87	1557.36	-5.89	-5.89	-6.25	8.59	226.67	0.01	MWD	6-axis
5	1615.86	2.80	236.37	58.28	1615.57	-7.38	-7.38	-8.53	11.28	229.13	0.04	MWD	6-axis
6	1644.61	2.69	236.51	28.75	1644.29	-8.14	-8.14	-9.68	12.65	229.93	0.04	MWD	6-axis
7	1668.50	2.86	238.36	23.89	1668.15	-8.77	-8.77	-10.65	13.80	230.56	0.08	MWD	6-axis
8	1699.25	2.65	238.80	30.75	1698.87	-9.54	-9.54	-11.92	15.26	231.33	0.07	MWD	6-axis
9	1727.71	2.60	239.64	28.46	1727.30	-10.20	-10.20	-13.03	16.55	231.95	0.02	MWD	6-axis
10	1756.63	2.51	238.85	28.92	1756.19	-10.86	-10.86	-14.14	17.83	232.48	0.03	MWD	6-axis
11	1786.00	2.34	240.28	29.37	1785.53	-11.49	-11.49	-15.21	19.07	232.93	0.06	MWD	6-axis
12	1814.34	2.29	240.62	28.34	1813.85	-12.06	-12.06	-16.21	20.20	233.36	0.02	MWD	6-axis
13	1843.18	2.18	239.19	28.84	1842.67	-12.62	-12.62	-17.18	21.32	233.70	0.04	MWD	6-axis
14	1901.41	1.96	237.87	58.23	1900.86	-13.72	-13.72	-18.98	23.42	234.14	0.04	MWD	6-axis
15	1931.65	1.78	237.81	30.24	1931.08	-14.24	-14.24	-19.81	24.40	234.29	0.06	MWD	6-axis
16	1960.46	1.72	237.86	28.81	1959.88	-14.71	-14.71	-20.56	25.28	234.41	0.02	MWD	6-axis
17	1989.04	1.62	235.40	28.58	1988.45	-15.17	-15.17	-21.25	26.11	234.49	0.04	MWD	6-axis
18	2047.36	1.44	230.77	58.32	2046.74	-16.10	-16.10	-22.50	27.67	234.41	0.04	MWD	6-axis
19	2075.90	1.46	228.72	28.54	2075.28	-16.57	-16.57	-23.05	28.39	234.30	0.02	MWD	6-axis
20	2104.97	1.26	223.46	29.07	2104.34	-17.04	-17.04	-23.55	29.07	234.11	0.08	MWD	6-axis
21	2133.36	1.26	222.20	28.39	2132.72	-17.50	-17.50	-23.97	29.68	233.87	0.01	MWD	6-axis
22	2161.89	1.14	222.54	28.53	2161.24	-17.94	-17.94	-24.38	30.27	233.64	0.04	MWD	6-axis
23	2190.93	1.21	218.85	29.04	2190.28	-18.39	-18.39	-24.76	30.85	233.40	0.04	MWD	6-axis
24	2220.38	1.11	218.25	29.45	2219.72	-18.86	-18.86	-25.13	31.42	233.12	0.03	MWD	6-axis
25	2249.29	1.04	218.39	28.91	2248.63	-19.29	-19.29	-25.47	31.95	232.87	0.02	MWD	6-axis
26	2278.19	0.90	218.62	28.90	2277.52	-19.67	-19.67	-25.78	32.42	232.65	0.05	MWD	6-axis
27	2307.52	0.99	219.17	29.33	2306.85	-20.04	-20.04	-26.08	32.89	232.45	0.03	MWD	6-axis
28	2336.95	1.01	219.68	29.43	2336.27	-20.44	-20.44	-26.41	33.39	232.26	0.01	MWD	6-axis

27	2307.52	0.99	219.17	29.33	2306.85	-20.04	-20.04	-26.08	32.89	232.45	0.03	MWD	6-axis
28	2336.95	1.01	219.68	29.43	2336.27	-20.44	-20.44	-26.41	33.39	232.26	0.01	MWD	6-axis
29	2365.20	0.95	216.00	28.25	2364.52	-20.82	-20.82	-26.70	33.86	232.05	0.03	MWD	6-axis
30	2394.92	1.02	211.37	29.72	2394.24	-21.25	-21.25	-26.98	34.35	231.78	0.04	MWD	6-axis

[(c)2001 Anadrill IDEAL ID6_1C_10]
ANADRILL SCHLUMBERGER Survey Report

13-Nov-2001 13:04:23

Page 3 of 3

Seq #	Measured depth (m)	Incl angle (deg)	Azimuth angle (deg)	Course length (m)	TVD depth (m)	Vertical section (m)	Displ +N/S- (m)	Displ +E/W- (m)	Total displ (m)	At Azim (deg)	DLS (deg/10m)	Srvy tool type	Tool qual type
31	2422.33	1.09	213.07	27.41	2421.64	-21.67	-21.67	-27.25	34.82	231.51	0.03	MWD	6-axis
32	2480.97	1.04	210.77	58.64	2480.27	-22.60	-22.60	-27.83	35.85	230.92	0.01	MWD	6-axis
33	2538.48	1.07	207.79	57.51	2537.77	-23.52	-23.52	-28.35	36.84	230.31	0.01	MWD	6-axis
34	2558.35	1.06	210.59	19.87	2557.64	-23.84	-23.84	-28.53	37.18	230.11	0.03	MWD	6-axis
35	2590.86	1.13	214.63	32.50	2590.13	-24.37	-24.37	-28.86	37.77	229.83	0.03	MWD	6-axis
36	2648.71	1.10	221.39	57.86	2647.98	-25.25	-25.25	-29.55	38.87	229.49	0.02	MWD	6-axis
37	2677.84	1.17	224.01	29.13	2677.10	-25.68	-25.68	-29.95	39.45	229.39	0.03	MWD	6-axis
38	2743.69	1.35	230.93	65.85	2742.94	-26.65	-26.65	-31.02	40.89	229.33	0.04	MWD	6-axis
39	2772.78	1.31	229.00	29.09	2772.02	-27.08	-27.08	-31.53	41.57	229.34	0.02	MWD	6-axis
40	2801.94	1.34	230.09	29.16	2801.17	-27.52	-27.52	-32.05	42.24	229.34	0.01	MWD	6-axis
41	2830.87	1.60	226.88	28.93	2830.09	-28.01	-28.01	-32.60	42.98	229.33	0.09	MWD	6-axis
42	2862.03	1.75	228.47	31.16	2861.24	-28.63	-28.63	-33.27	43.89	229.29	0.05	MWD	6-axis
43	2889.90	2.04	226.84	27.87	2889.10	-29.25	-29.25	-33.95	44.81	229.26	0.11	MWD	6-axis
44	2919.06	2.08	227.19	29.16	2918.24	-29.96	-29.96	-34.72	45.86	229.21	0.01	MWD	6-axis
45	2948.01	1.81	221.56	28.95	2947.17	-30.66	-30.66	-35.41	46.84	229.11	0.11	MWD	6-axis
46	2977.28	1.63	219.95	29.27	2976.43	-31.33	-31.33	-35.98	47.71	228.96	0.06	MWD	6-axis
47	3005.24	1.51	212.47	27.96	3004.38	-31.94	-31.94	-36.44	48.46	228.76	0.08	MWD	6-axis
48	3033.85	1.32	208.32	28.61	3032.98	-32.55	-32.55	-36.80	49.13	228.50	0.08	MWD	6-axis
49	3063.37	0.92	208.53	29.52	3062.49	-33.06	-33.06	-37.07	49.67	228.27	0.14	MWD	6-axis
50	3086.82	0.89	200.42	23.45	3085.94	-33.39	-33.39	-37.22	50.01	228.10	0.06	MWD	6-axis
51	3119.68	0.65	170.45	32.86	3118.80	-33.82	-33.82	-37.28	50.33	227.79	0.14	MWD	6-axis
52	3149.04	1.19	129.46	29.36	3148.15	-34.18	-34.18	-37.02	50.38	227.29	0.28	MWD	6-axis
53	3177.87	1.26	140.82	28.83	3176.98	-34.61	-34.61	-36.59	50.36	226.59	0.09	MWD	6-axis
54	3206.58	1.60	135.02	28.71	3205.68	-35.14	-35.14	-36.10	50.38	225.78	0.13	MWD	6-axis
55	3237.14	1.95	129.83	30.56	3236.22	-35.77	-35.77	-35.40	50.33	224.70	0.13	MWD	6-axis
56	3264.76	2.44	130.63	27.62	3263.82	-36.46	-36.46	-34.60	50.26	223.50	0.18	MWD	6-axis
57	3294.49	2.68	134.69	29.73	3293.52	-37.36	-37.36	-33.62	50.26	221.99	0.10	MWD	6-axis
58	3317.25	2.89	133.42	22.76	3316.26	-38.13	-38.13	-32.83	50.31	220.73	0.10	MWD	6-axis
59	3329.04	2.96	135.16	11.79	3328.03	-38.55	-38.55	-32.40	50.35	220.04	0.10	MWD	6-axis
60	3345.00	3.00	137.00	15.96	3343.97	-39.15	-39.15	-31.82	50.45	219.11	0.06	Projection to TD	

[(c)2001 Anadrill IDEAL ID6_1C_10]

Company: Bass Strait Oil Company

Well: Melville-1 8.5 in. hole

Field: Gippsland Basin

Rig: Ocean Bounty

State: Victoria

IDEAL services from Anadrill

VISION Resistivity
1:200 Measured Depth
Recorded Mode

Schlumberger